

Saugkanülen Canules d'aspiration

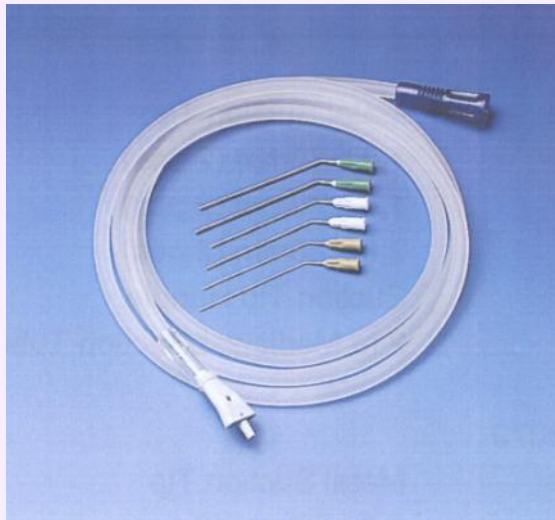



Serie SE mit Unterbrecherloch Série SE avec orifice d'interruption

Art. Nr. 29-1040 (UK12-197SE) P/50
Ø 4,0 mm L 127 mm

Art. Nr. 29-1043 (UK9-197SE) P/50
Ø 3,0 mm L 127 mm

Art. Nr. 29-1044 (UK7-165SE) P/50
Ø 2,1 mm L 95 mm

Art. Nr. 29-1045 (UK5-165SE) P/50
Ø 1,6 mm L 95 mm

Art. Nr. 29-1046 (UK3-175SE) P/50
Ø 1,2 mm L 150 mm

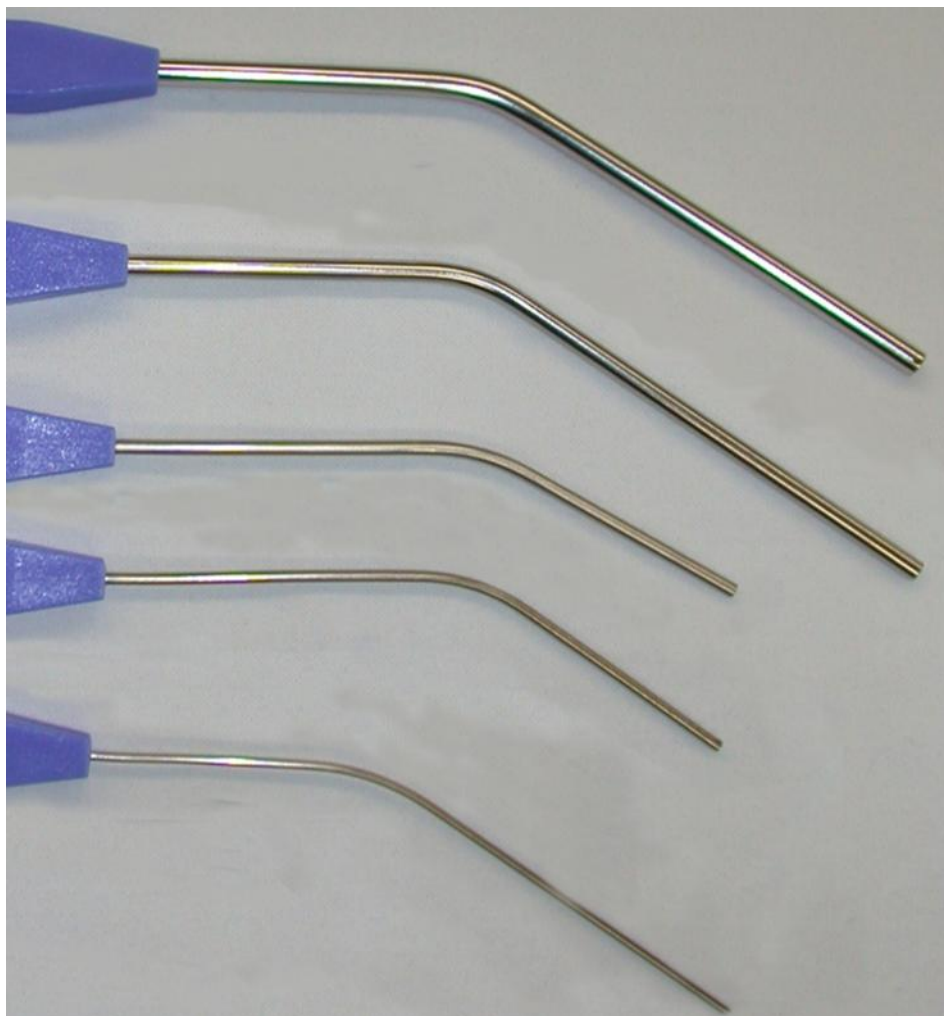

passend zu Saugschlauch Art. Nr. 58-6099900
adaptable à tubulure art. No 58-6099900

Stahl Saugkanülen mit 3-Kantgriff und Unterbrecherloch Canules d'aspiration en acier avec manche à 3 arêtes avec orifice d'interruption



Art. Nr. 29-1020 (US7-150 SF) P/50
Ø 2,1 mm L 95 mm

Art. Nr.29-1022 (US3-150 SF) P/50
Ø 1,2 mm L 105 mm

Art. Nr.29-1023 (US5-150 SF) P/50
Ø 1,6 mm L 95 mm

Art. Nr.29-1024 (US7-130 SF) P/50
Ø 2,1 mm L 95 mm

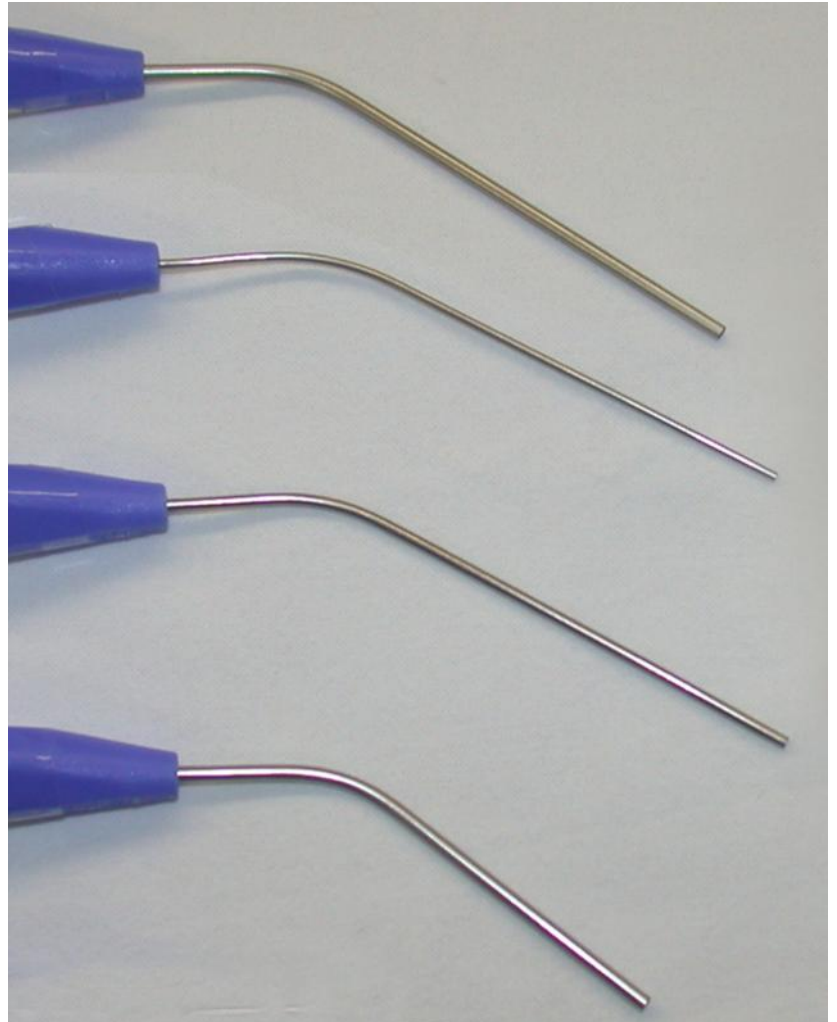

passend zu Saugschlauch Art. Nr. 58-6099900
adaptable à tubulure art. No 58-6099900

Stahl Saugkanülen mit 3-Kantgriff und Unterbrecherloch Canules d'aspiration en acier avec manche à 3 arêtes avec orifice d'interruption



Art. Nr. 29-1030 (US12-182 SF) P/50
Ø 4,0 mm L 127 mm

Art. Nr. 29-1033 (US9-182 SF) P/50
Ø 3,0 mm L 127 mm

Art. Nr. 29-1034 (US7-170 SF) P/50
Ø 2,1 mm L 95 mm

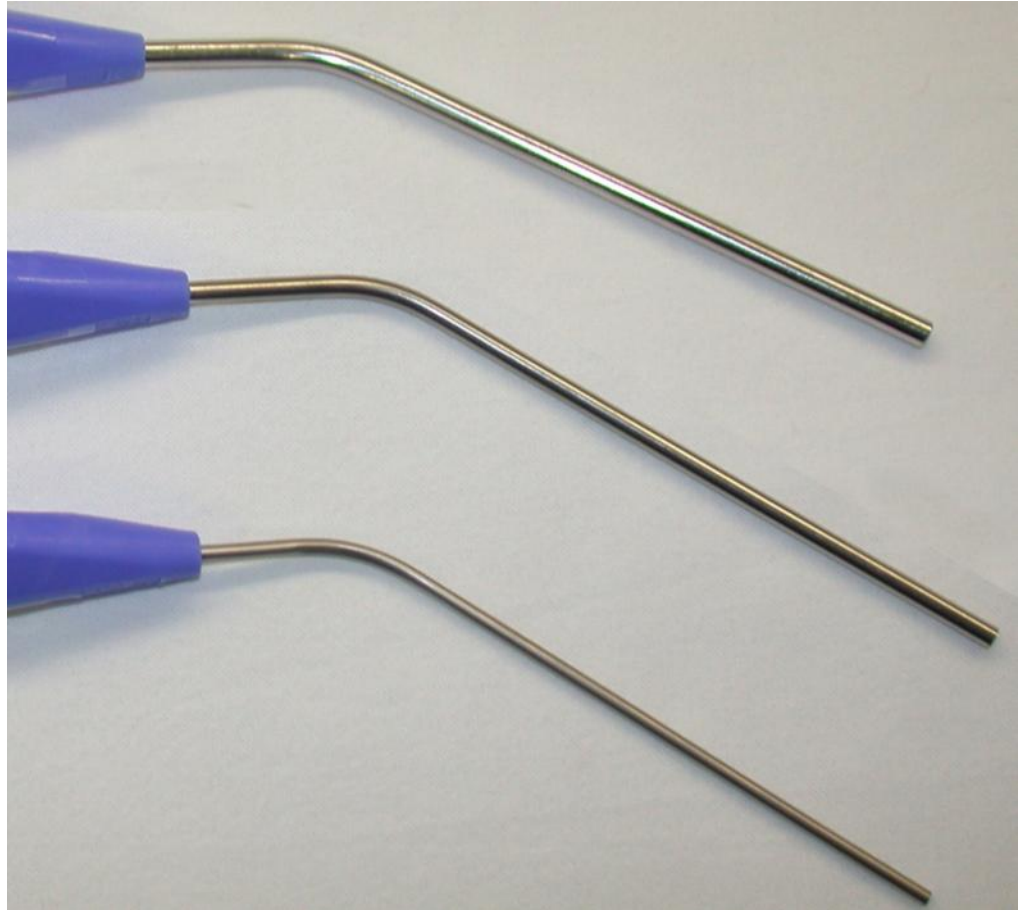

passend zu Saugschlauch Art. Nr. 58-6099900
adaptable à tubulure art. No 58-6099900

Medioplast Otologie

Einweginstrumente, steril Instruments à usage unique, stérile

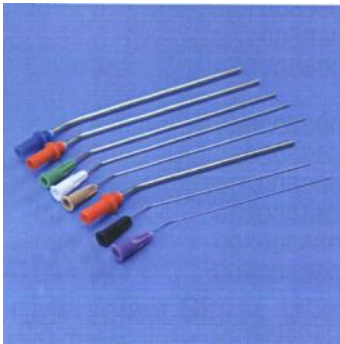

Ohrsaugkanülen Metall

Canules d'aspiration, oreille P/60

Art. Nr. 58-66500040	0,4 x 70 mm	P/60
Art. Nr. 58-66500070	0,7 x 70 mm	P/60
Art. Nr. 58-66500100	1,0 x 70 mm	P/60
Art. Nr. 58-66500140	1,4 x 70 mm	P/60
Art. Nr. 58-66500208	2,0 x 70 mm	P/60

Längen 80 und 100 mm auf Anfrage
Longueurs 80 et 100 mm sur demande

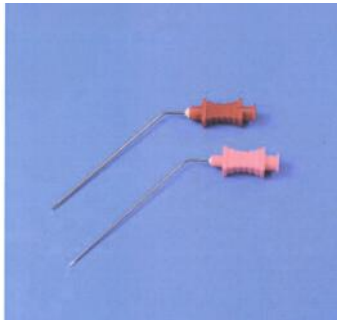

Myringotomie Messer lanzettform abgebogen

Bistouri lancéole

Art. Nr. 58-66121370	1,3 x 70 rot	P/30
Art. Nr. 58-66121070	1,0 X 70 pink	P/30



Myringotomie Kit

je 1 Otosauger 1,4/ 2,0 / 3,0 mm
1 Saughandgriff
1 Myringotomie Messer
3 Ohrspeculum: 4/5/6 mm
2 Kompressen
1 Abdecktuch 50 x 70 cm

Art. Nr. 58-66143300

Myringotomie Kit

3 Canules: 1,4 / 2,0 / 3,0 mm
1 poignée de canule d'aspiration
1 bistouri lancéolé
3 spéculums d'oreille: 4/5/6 mm
2 compresses
1 champ 50 x 70

P/30



MO-Saugkanülen Kit

je 2 Otosauger 1,0/1,4/2,0 mm
1 Saughandgriff
1 Absaugschlauch 200 cm

Art. Nr. 58-66502070

Canules d'aspiration Kit, oreille

6 Canules: 2 x 1,0/1,4/2,0 mm
1 poignée de canule d'aspiration
1 tubulure d'aspiration 200 cm

P/30



Suction Handgriff mit Unterbrecherloch

poignée de canule d'aspiration avec orifice de déclenchement

Art. Nr. 58-66500992

P/75

Suction Handgriff ohne Unterbrecherloch

poignée de canule d'aspiration sans orifice de déclenchement

Art. Nr. 58-66505009

P/75

Medioplast Otologie

Einweginstrumente, steril Instruments à usage unique, stérile

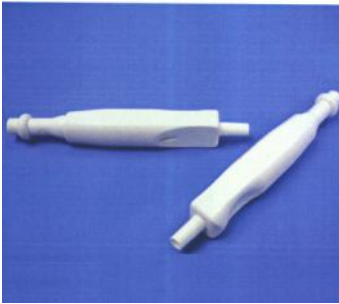

Suction Handgriff lang, mit Unterbrecherloch
Poignée de canule d'aspiration longue avec orifice de déclenchement

Art. Nr. 58-66500990

P/25



Saugkanülen PVC
Canules d'aspiration

Art. Nr. 58-66100627	2,0 x 150 mm, grün / vert	P/40
Art. Nr. 58-66100635	3,0 x 150 mm, blau / bleu	P/40
Art. Nr. 58-66100643	4,0 x 150 mm, weiss / blanc	P/40

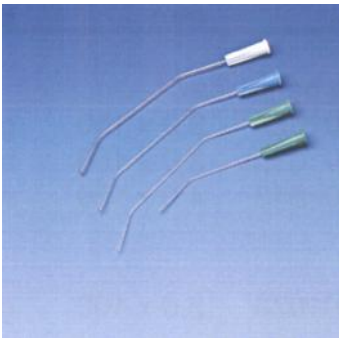

Saugkanülen PVC
Canules d'aspiration

Art. Nr. 58-66101627	2,0 x 150 mm, grün / vert	P/40
Art. Nr. 58-66101635	3,0 x 150 mm, blau / bleu	P/40
Art. Nr. 58-66101643	4,0 x 150 mm, weiss / blanc	P/40
Art. Nr. 58-66101023	2,0 x 100 mm, grün / vert	P/40



Sject Ohr-Spülspritze
Sject Seringe

Art. Nr. 58-61990011

P/20

Die Saugkanülen können auch in der Kiefer- und Dentalchirurgie eingesetzt werden
Les canules d'aspiration peuvent également être utilisées dans la chirurgie maxillo-faciale et dentale



Nasensaugkanülen Metall Canules d'aspiration

Art. Nr. 58-66501020	2,0 x 150 mm	P/25
Art. Nr. 58-66501030	3,0 x 150 mm	P/25
Art. Nr. 58-66501040	4,0 x 150 mm	P/25

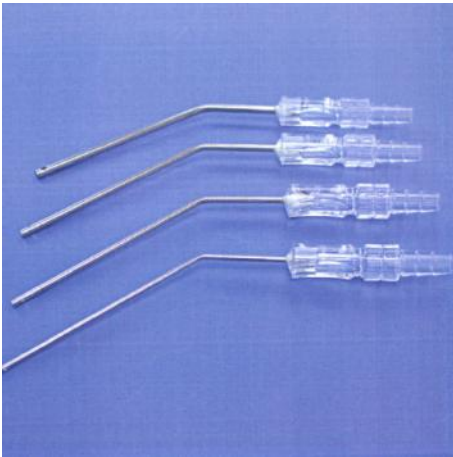

Nasensaugkanülen Metall, seitlich gelocht Canules d'aspiration métalliques, avec orifice latéral

Art. Nr. 58-66509020	2,0 x 110 mm	P/25
Art. Nr. 58-66509025	2,5 x 110 mm	P/25
Art. Nr. 58-66509030	3,0 x 110 mm	P/25
Art. Nr. 58-66509035	3,5 x 110 mm	P/25

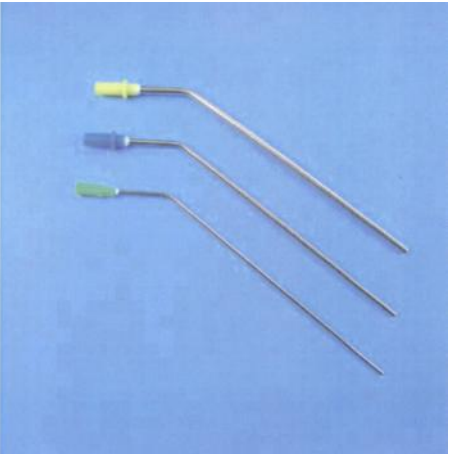

Nasensaugkanülen Metall Canules d'aspiration métallique

Art. Nr. 58-66516020	2,0 x 150 mm	grün / vert	P/40
Art. Nr. 58-66516030	3,0 x 150 mm	blau / bleu	P/40
Art. Nr. 58-66516040	4,0 x 150 mm	gelb / jaune	P/40

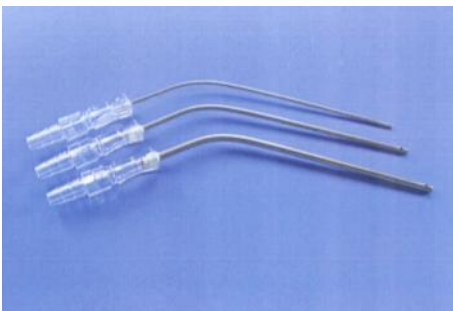

Nasensaugkanülen Metall mit Unterbrecherloch Canules d'aspiration avec trou

Art. Nr. 58-66511020	2,0 x 150 mm	P/25
Art. Nr. 58-66511030	3,0 x 150 mm	P/25
Art. Nr. 58-66511040	4,0 x 150 mm	P/25

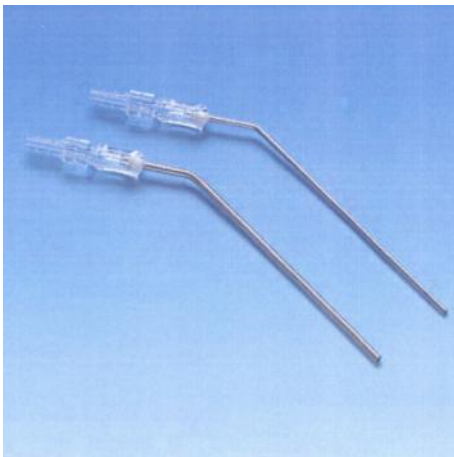

Nasensaugkanülen Metall Canules d'aspiration

Art. Nr. 58-66516120	2,0 x 150 mm	P/25
Art. Nr. 58-66516130	3,0 x 150 mm	P/25
Art. Nr. 58-66516140	4,0 x 150 mm	P/25

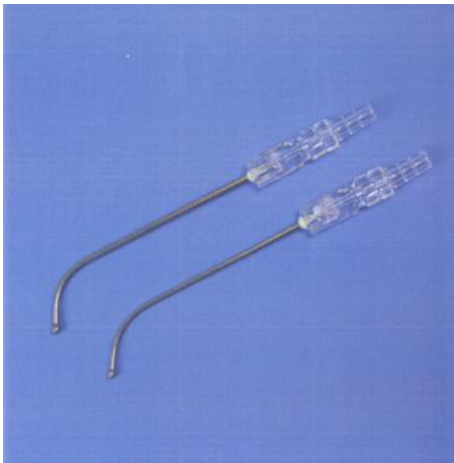

Endonasale Saugkanülen Metall Canules d'aspiration endonasaes

Art. Nr. 58-66503020	2,0 x 150 mm	P/25
Art. Nr. 58-66503025	2,5 x 150 mm	P/25
Art. Nr. 58-66503030	3,0 x 150 mm	P/25
Art. Nr. 58-66503035	3,5 x 150 mm	P/25
Art. Nr. 58-66503040	4,0 x 150 mm	P/25



Nasensaugkanülen Metall Canules d'aspiration

Art. Nr. 58-66508020	2,0 x 120 mm	P/25
Art. Nr. 58-66508030	3,0 x 120 mm	P/25
Art. Nr. 58-66508040	4,0 x 120 mm	P/25

Die Nasensaugkanülen können auch in der Neurochirurgie eingesetzt werden
Les canules d'aspiration peuvent également être utilisées dans la neurochirurgie

Medioplast Oesophagoskopie

Einweginstrumente, steril
Instruments à usage unique, stérile

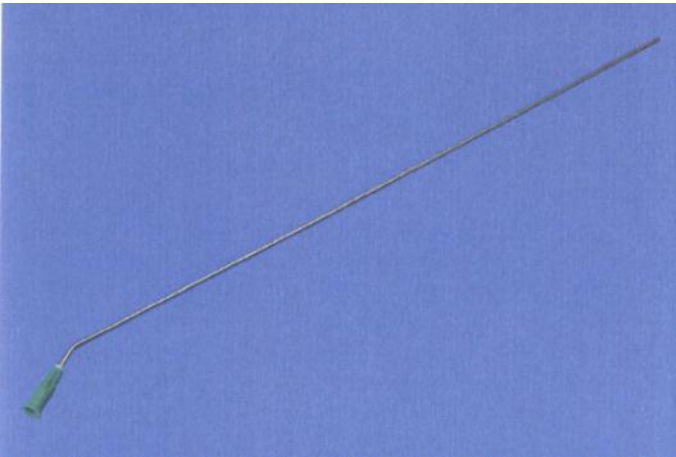

Bronchoskopie Saugkanülen
Bronchoskopie Canules d'aspiration

Art. Nr. 58-61626280 2,0 x 300 mm P/10

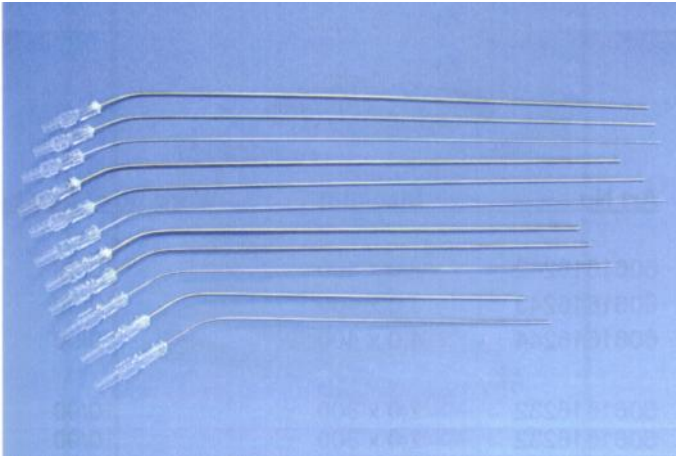

Broncho- / Oesophagoskopie Saugkanülen
Broncho- / Oesophagoskopie Canules d'aspiration

Art. Nr. 58-61616232 2,0 x 300 mm P/10

Art. Nr. 58-61616233 3,0 x 300 mm P/10

Art. Nr. 58-61616234 4,0 x 300 mm P/10

Lieferbar auch in den Längen 400, 500 und 550 mm
Livvable aussi en 400, 500 et 550 mm

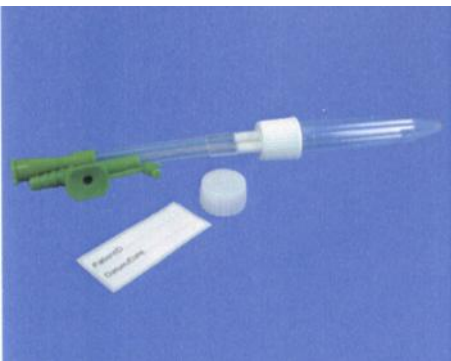

Sekret-Absaugset für die Trachea
Set d'aspiration de sécrétion pour La trachea

Art. Nr. 58-6066565 P/50

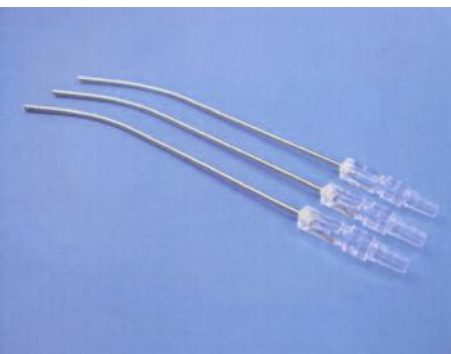

Tonsillen Saugkanülen
Amigdales Canules d'aspiration

Art. Nr. 58-66502040 4,0 x 190 mm p/20

Medioplast Saugschläuche

Einwegmaterial steril
Matériel à usage unique, stérile

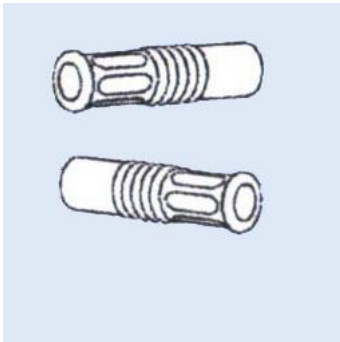

Saugschlauch 5,6 x 8,2 mm, Länge 200 cm
tubulure d'aspiration 5,6 x 8,2 mm longueur 200 cm

Art. Nr. 58-6099900

P/50

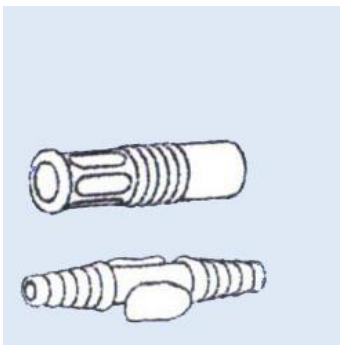

Saugschlauch 5,6 x 8,2 mm, Länge 200 cm
tubulure d'aspiration 5,6 x 8,2 mm longueur 200 cm

Art. Nr. 58-6099910

P/50

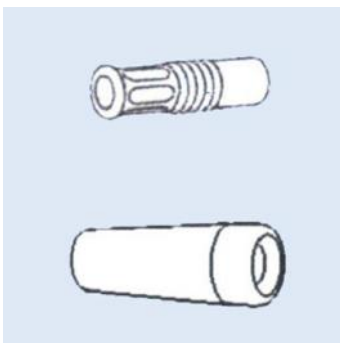

Saugschlauch 6 x 8 mm, Länge 350 cm
tubulure d'aspiration 6 x 8 mm longueur 350 cm

Art. Nr. 58-6099999

P/40

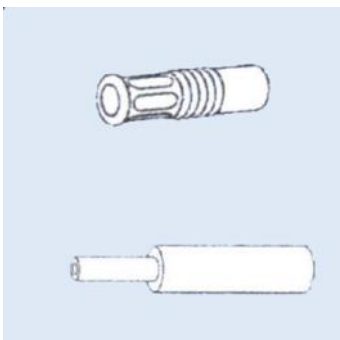

Saugschlauch 6 x 8 mm, Länge 350 cm
tubulure d'aspiration 6 x 8 mm longueur 350 cm

Art. Nr. 58-6099992

P/40



novimed

Aus der Praxis—für die Praxis L'expérience au service de la pratique

Flexibel • kompetent • dynamisch

Otologie
Rhinologie
Laryngologie
Kieferchirurgie
Implantologie

Flexibel • compétent • dynamique

Otologie
Rhinologie
Laryngologie
Chirurgie maxillo-faciale
Implantologie

